

**ABSTRACT.** The study of seismic potential is essential to the implementation of population protection. In order to anticipate potential hazard and limit risks, three information are essential: past earthquakes location, size of rupture and detailed induced deformation. Having access to these earthquakes remains a privilege and depends on the chance to have an instrument in the right place at the right time. Indeed, GPS and radar methods emerged in the 1990s, while optical instruments gathered only scattered and heterogeneous aerial photos and satellite images with a resolution of about ten kilometres before 2010s. We therefore for the first time propose access to a promising image archive for all types of study of land deformation, with a resolution of about two metres, over an area of 100 km<sup>2</sup>, well distributed geographically and extending to the middle of the 1960s. These are the images from the american spy satellite "CORONA KH-4B". On this occasion, this archive enabled the detailed ground deformation study of the 1976 Luhuo, Eastern Tibet earthquake, key information for our global study: understand upper crust coseismic deformation of strike-slip faults.

## How to study ground deformation due to faulting?

Temporal distribution of remote sensing and geodesic tools

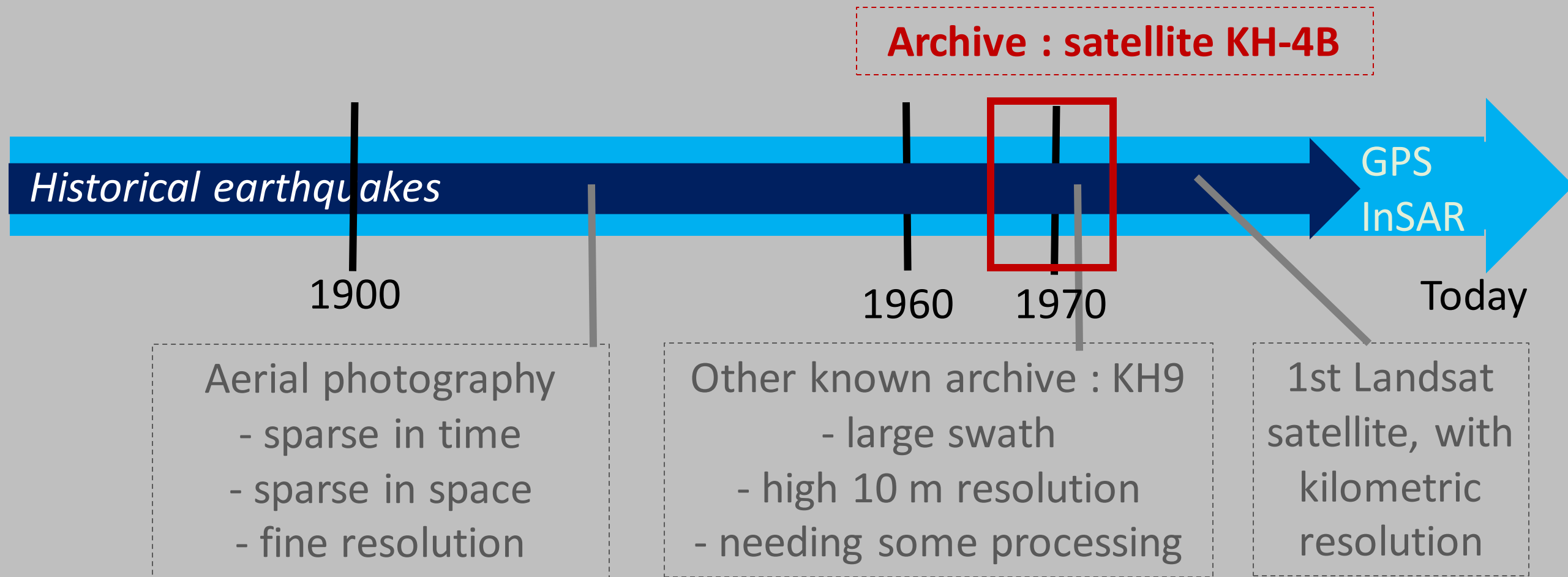

Active fault deformation is characterized by displacement ranging from millimeters/year (aseismic slip) to meters/second (major earthquake) and surface deformation can be documented with:

- InSAR
- optical image correlation (Van Puymbroeck et al., 2000)
- field mapping of rupture and coseismic offsets

To prevent hazard → characterize the maximal potential earthquake  
→ detail each rupture size, slip amplitude, location

During the 1947-1991 Cold War, the american and russian governments initiated the first generation of imaging reconnaissance satellites. **What is the potential of US CORONA KH-4B archive, little used for geodetic analysis? Can we overcome its drawbacks to access past earthquakes?**

## 1. A new tool : CORONA KH-4B...

KH-4B images taken in 1967-1969 and 1970-1972 (Song et al., 2015)

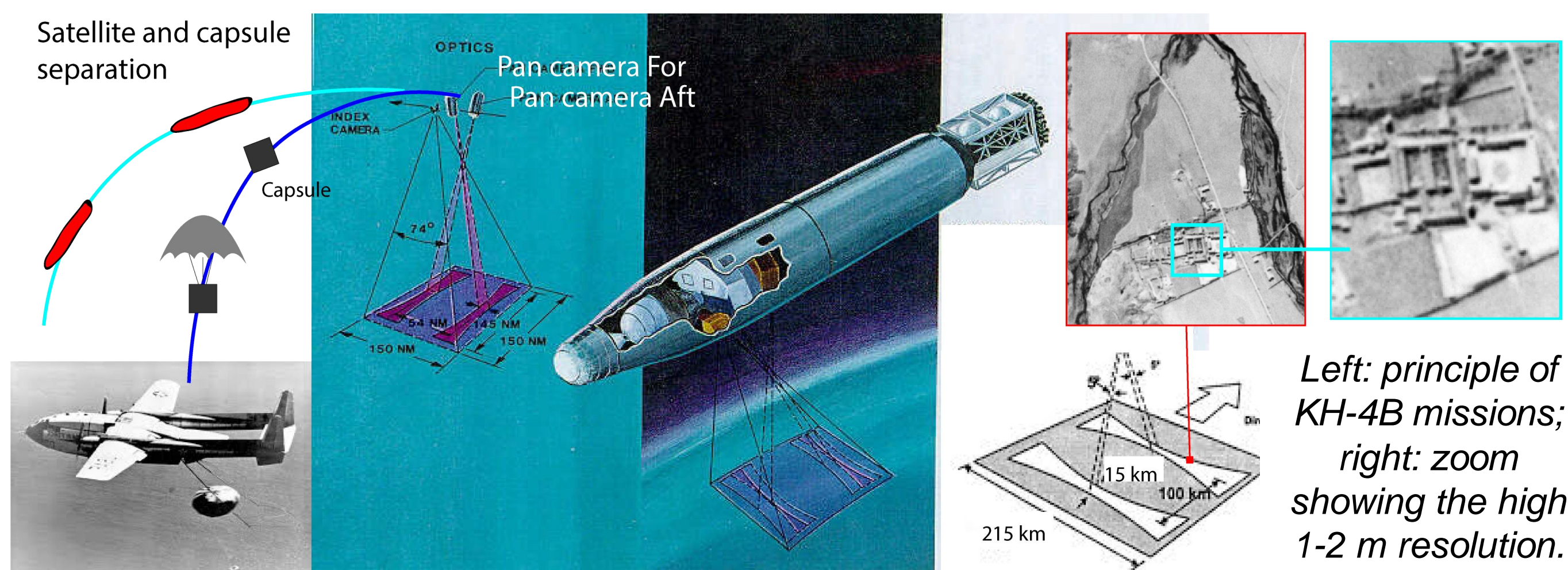
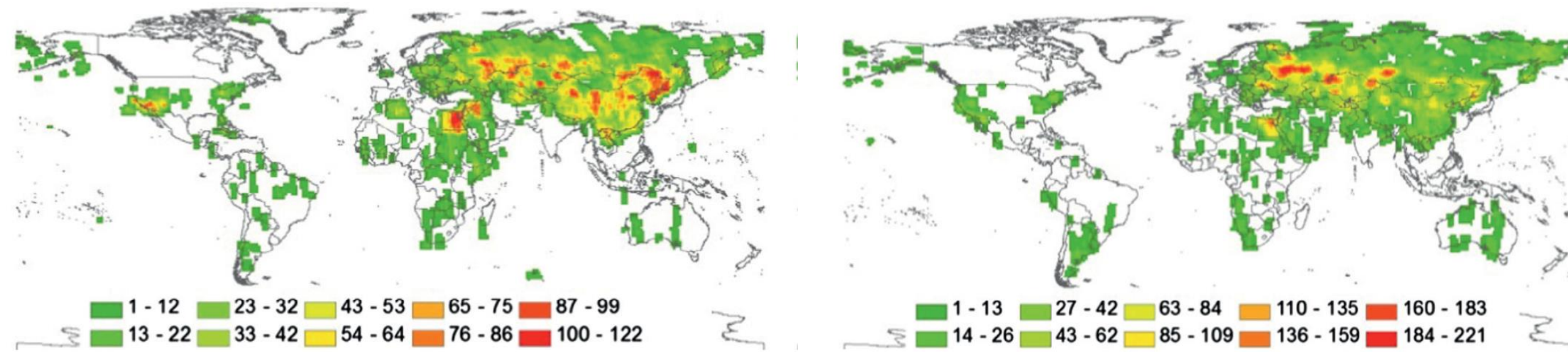

## 2. A major fault in Eastern Tibet: The Xianshuihe Fault

Rare example of a structurally mature continental strike-slip fault recently broken in. One of the most dangerous faults of China with 35 Mw ≥ 6.5 historical earthquakes recorded since 1327. This study focuses on Mw 7.6 1973 Luhuo EQ. Indeed, about twenty 1968 KH-4B images cover the segment ruptured.

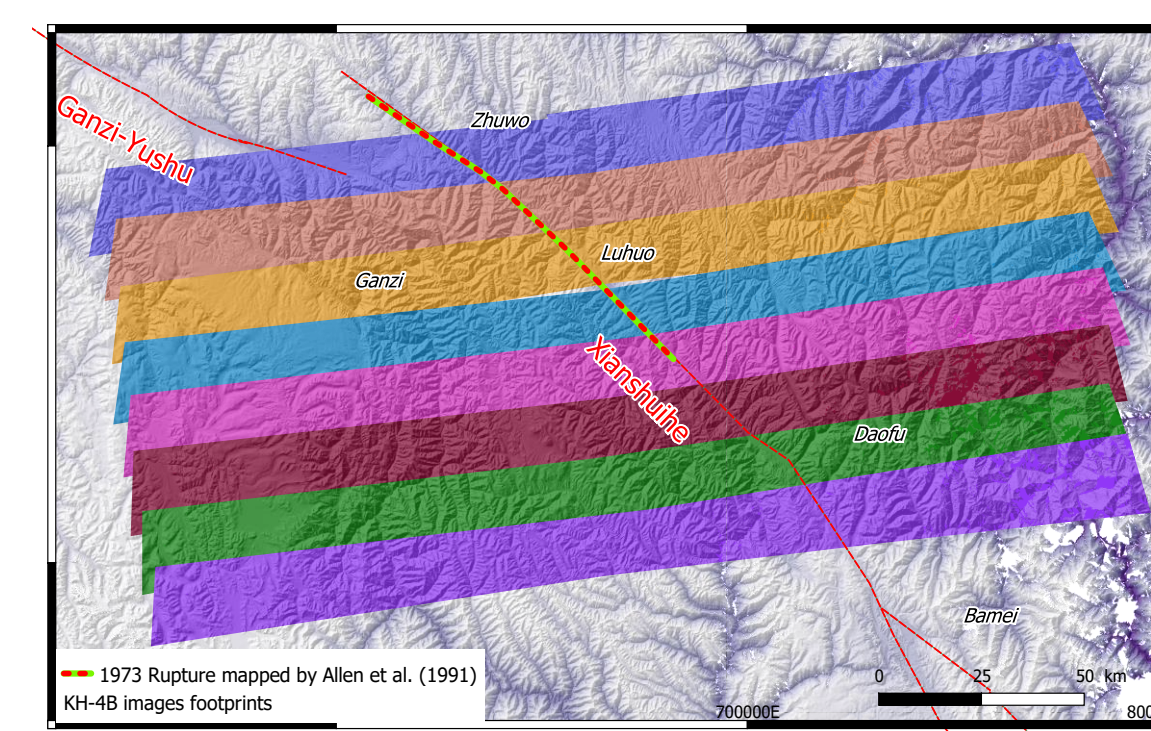
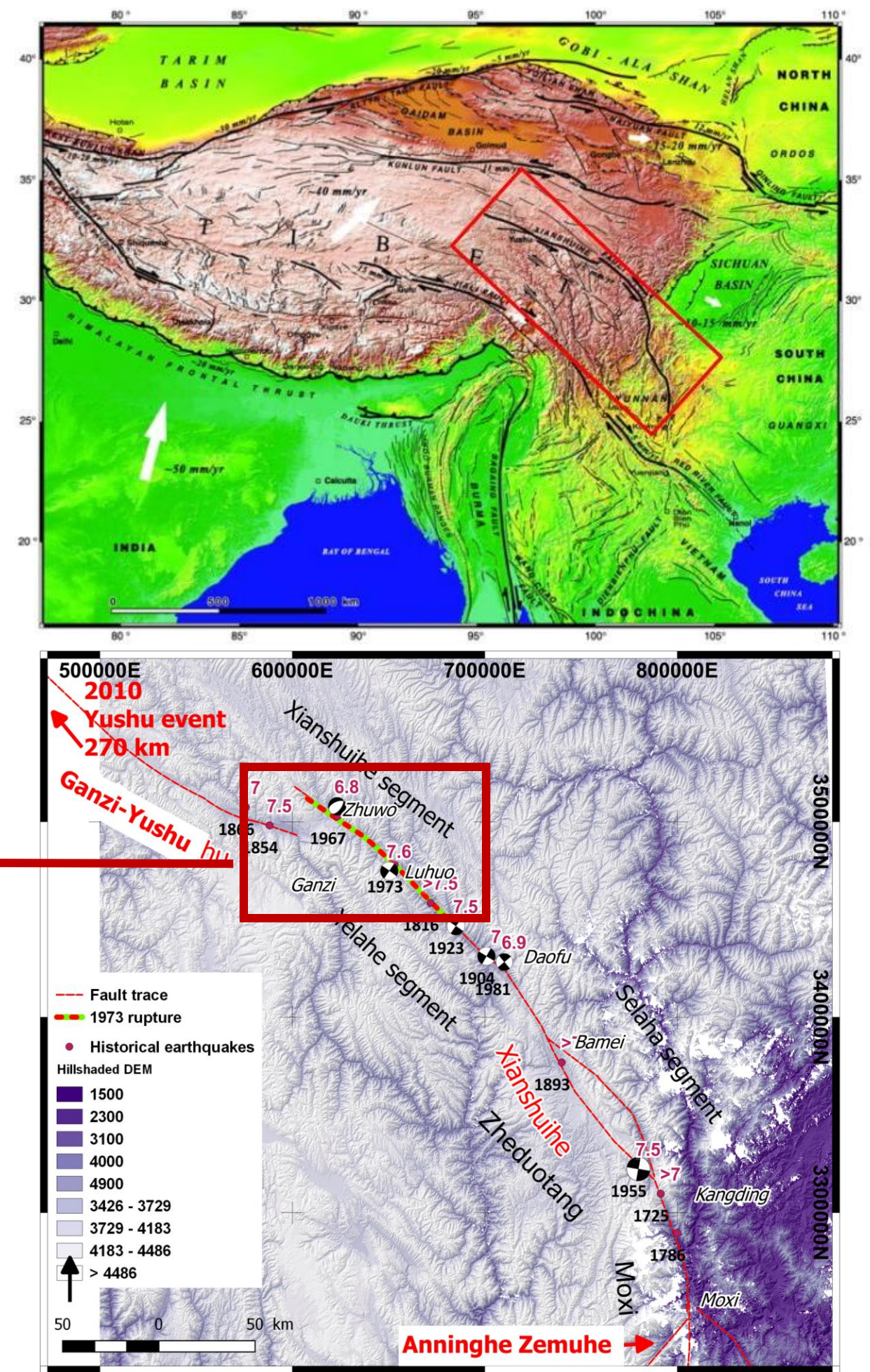

Up right: Map from Taponnier et al. (2001). Right: location of the Xianshuihe fault, cities and historical quakes; Up: 1968 KH-4B images footprints above the fault.

## ... but KH-4B acquisition leads to distortions...

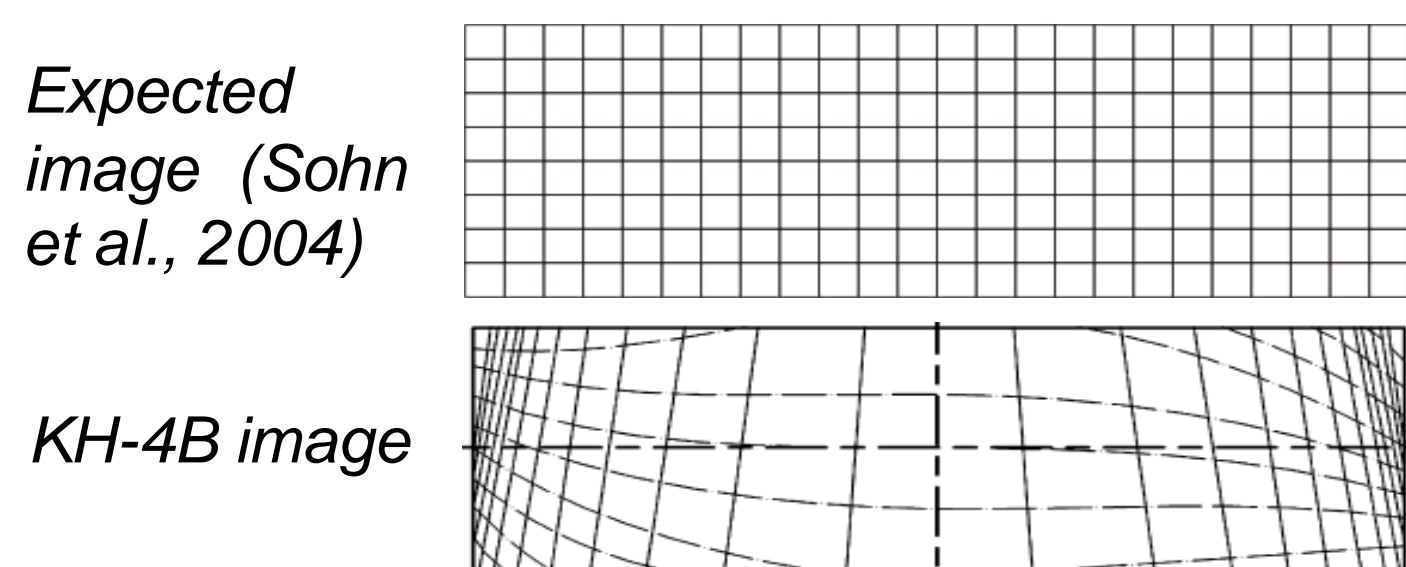

### Causes ?

- Position moving with the lens
- Panoramic distortion
- Image compensation during exposure
- Tilted camera

## ...that we aimed and succeeded to remove.

Iterative testing and processing of the archive

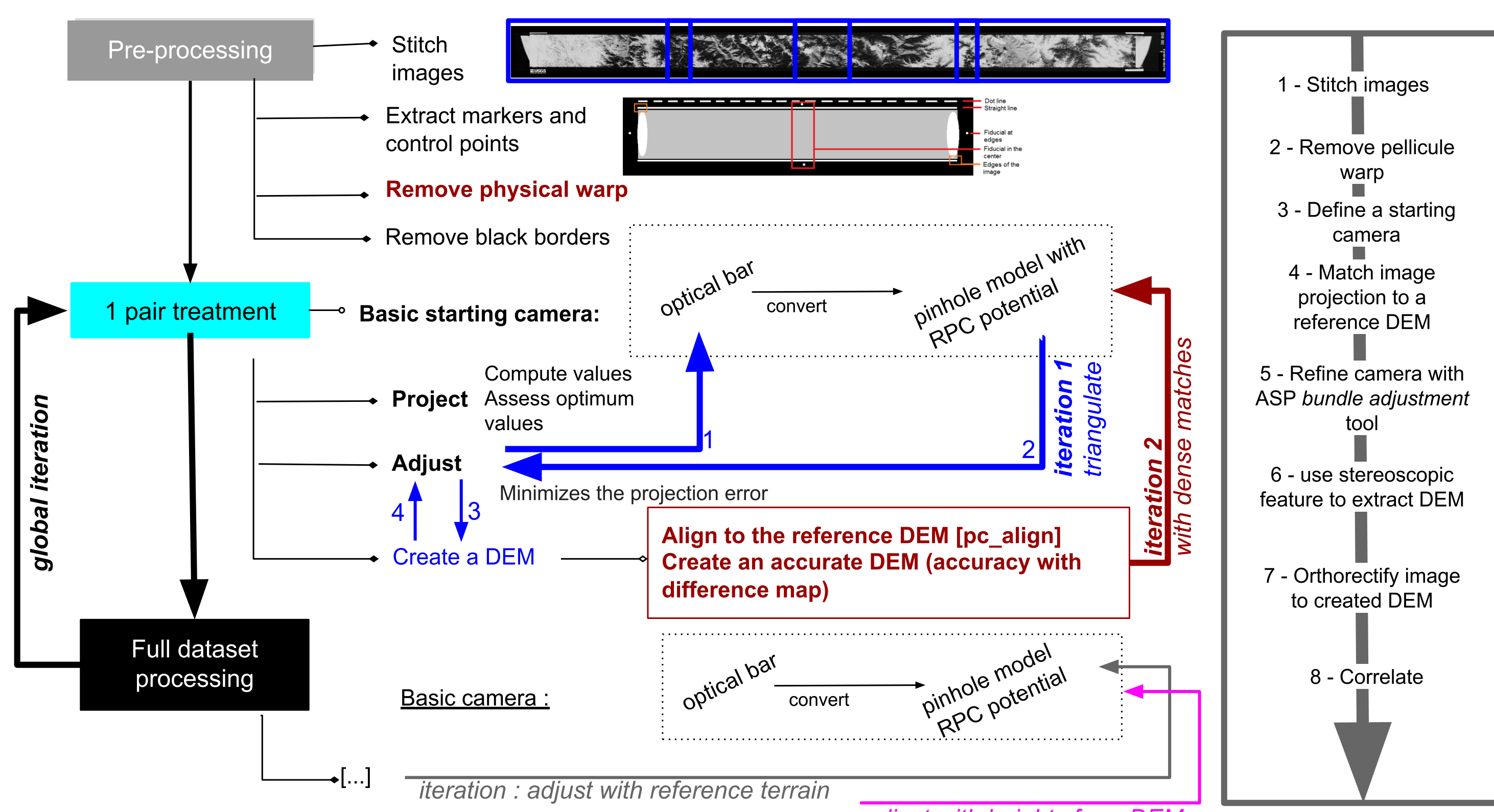

## 3. 1973 Luhuo earthquake study using KH-4B

High resolution displacement maps and rupture morphology map

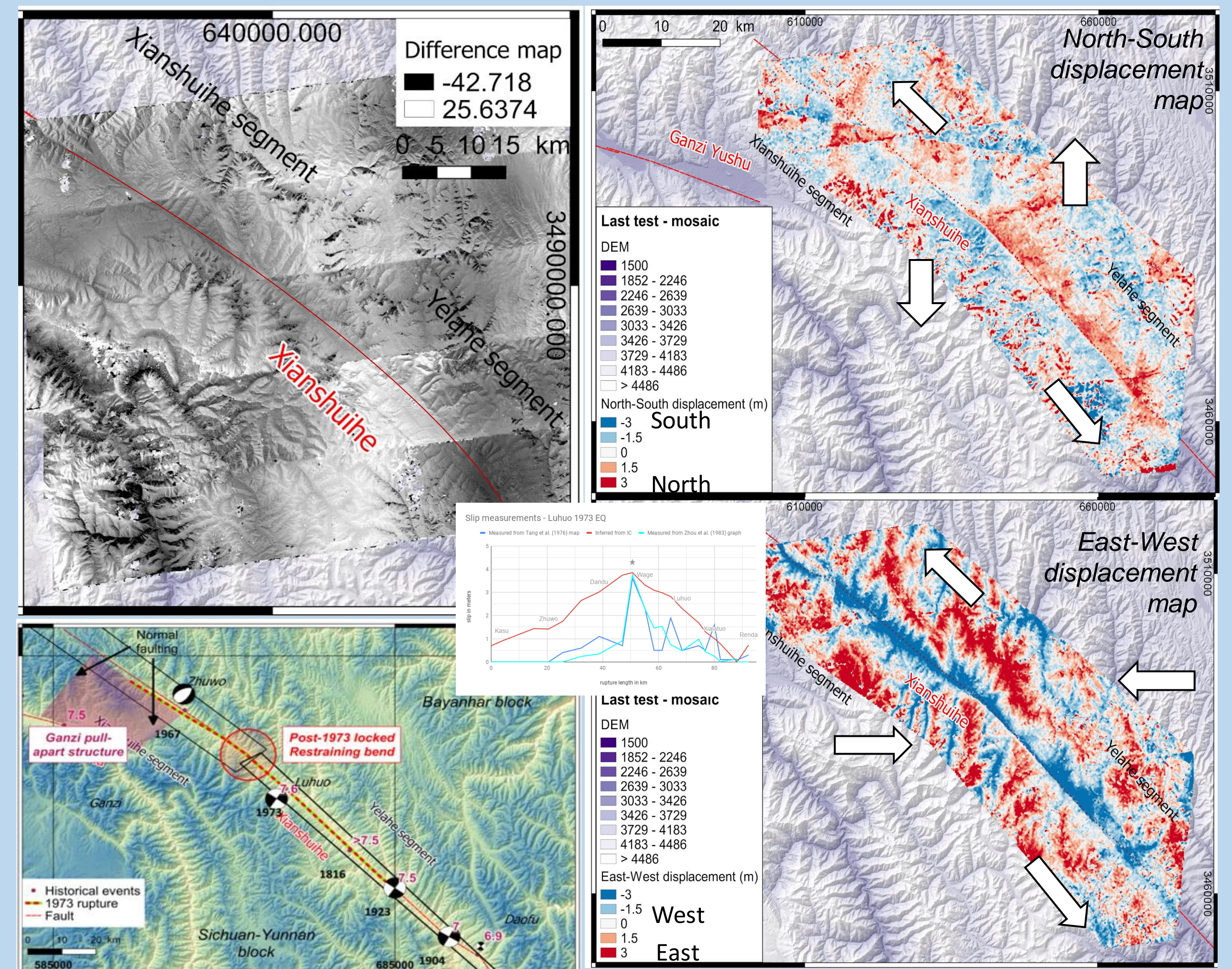

## KH-4B potential unleashed

To retrieve the "small" displacements typically associated with EQ using image correlation requires a high precision distortion removal. Our success for 1973 Luhuo EQ this case shows our method has general potential for other studies. Our method requires further improvement of distortion removal to get rid of noise and artifacts. In the future we aim to understand shallow upper crust coseismic slip deficit for mature and immature strike-slip faults (right figure from Fialko et al., 2006).

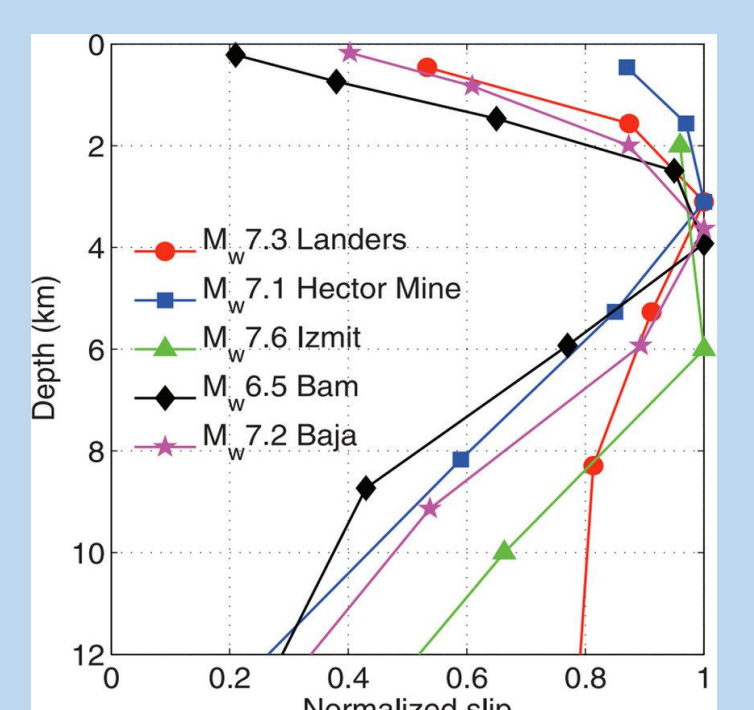

Allen, C. R., Zhuoli, L., Hong, Q., Xueze, W., Huawei, Z. and Weishi, H.: Field study of a highly active fault zone: The Xianshuihe fault of southwestern China, Geological Society of America Bulletin, 103(9), 1178-1199, 1991.  
Beyer, R. A., Alexandrov, O. and McMichael, S.: The Ames Stereo Pipeline: NASA's Open Source Software for Deriving and Processing Terrain Data, Earth and Space Science, 5(9), 537-548, doi:10.1029/2018EA000402, 2018.  
Fialko, Y., Sandwell, D., Simons, M. and Rosen, P.: Three-dimensional deformation caused by the Bam, Iran, earthquake and the origin of shallow slip deficit, Nature, 435(7040), 295-299, doi:10.1038/nature04323, 2005.  
Sohn, H.-G., Kim, G.-H. and Yom, J.-H.: Mathematical modelling of historical reconnaissance CORONA KH-4B Imagery, Photogrammetric Record, 19(105), 51-66, doi:10.1046/j.0031-868x.2003.00257.x, 2004.  
Song, D.-X., Huang, C., Sexton, J. O., Channan, S., Feng, M. and Townshend, J. R.: Use of Landsat and Corona data for mapping forest cover change from the mid-1960s to 2000s: Case studies from the Eastern United States and Central Brazil, ISPRS Journal of Photogrammetry and Remote Sensing, 103, 81-92, doi:10.1016/j.isprsjprs.2014.09.005, 2015.  
Taponnier, P., Zhiqing, X., Roger, F., Meyer, B., Amaud, N., Wittlinger, G. and Jingsui, Y.: Oblique stepwise rise and growth of the Tibet Plateau, Science, 294(5547), 1671-1677, doi:10.1126/science.1105978, 2001.  
Van Puymbroeck, N., Michel, R., Binet, R., Avouac, J.P. and J. Taboury: Measuring earthquakes from optical satellite images, Applied Optics Information Processing, 39, 23, 1-14, 2000.